



[www.adosa.es](http://www.adosa.es)



- DIRETTIVA SULLA COMPATIBILITÀ ELETTROMAGNETICA 89/336/CEE
- DIRETTIVA SULLA BASSA TENSIONE 73/23/CEE
- NORMA DI SICUREZZA PER I SISTEMI DI TRASMISSIONE IDRAULICA EN 982

## DISSUASORI A SCOMPARSA 2023

La vostra protezione nelle mani di professionisti.



# PRODUTTORI DI DISSUASORI

In qualità di pionieri nella produzione di dissuasori retrattili, disponiamo di uno dei cataloghi più ampi del mercato, in grado di soddisfare le esigenze dei nostri clienti.

Offriamo dissuasori di qualità a prezzi competitivi, minimizzando i costi senza ridurre la qualità.

La nostra offerta va da gamme economiche a dissuasori di alta sicurezza; inoltre, personalizziamo i dissuasori per installazioni di altre marche, evitando così i costosi lavori di muratura per la loro sostituzione.

L'esperienza acquisita in tutti questi anni ci permette di sviluppare ogni tipo di soluzione per i nostri clienti.



### SYDNEY (GAMMA ALTA)

ACCIAIO INOSSIDABILE



PEASY220X500

Spessore:  
8,5 mm.    Ø 114 mm.  
8 mm.      Ø 220 mm.



Installazione:



Chassis.



+ Cassone a perdere.



### MELBOURNE (GAMMA ALTA)

FERRO ZINCATO



PEAME220X500

Spessore:  
10 mm.    Ø 114 mm.  
10 mm.    Ø 220 mm.

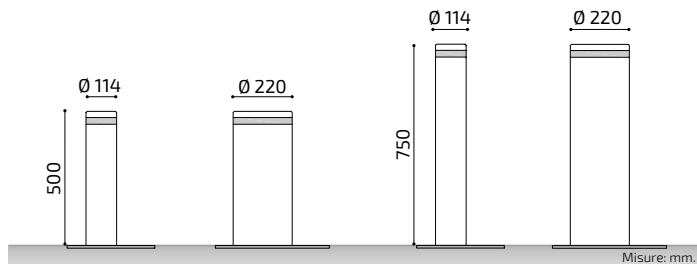

Installazione:



Chassis.



+ Cassone a perdere.



## OSLO (GAMMA MEDIA)

ACCIAIO INOSSIDABILE

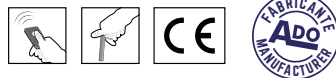

PEASY220X500

Spessore:  
3 mm. Ø 114 mm.  
3,7 mm. Ø 220 mm.

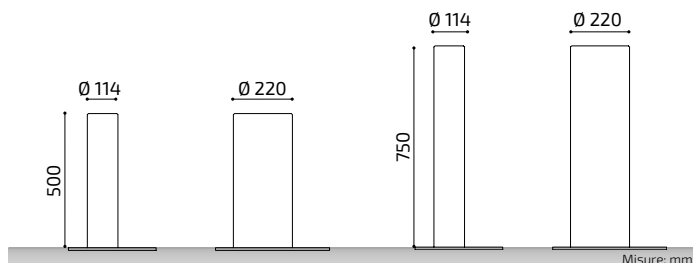

Installazione:

Chassis. + Cassone a perdere. | Nastro riflettente facoltativo.

■ Su richiesta AISI 316.



## ESTOCOLMO (GAMA MEDIA)

FERRO ZINCATO

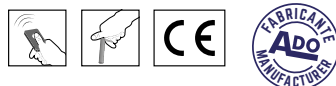

PEAME220X500

Spessore:  
4 mm. Ø 114 mm.  
5 mm. Ø 220 mm.

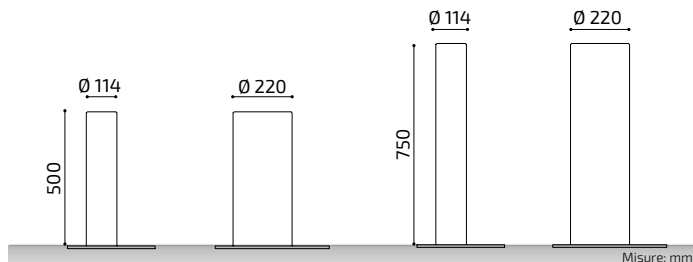

Installazione:

Chassis. + Cassone a perdere.



### LUXEMBURGO (GAMMA ALTA)

ACCIAIO INOSSIDABILE



PEMLU220X500

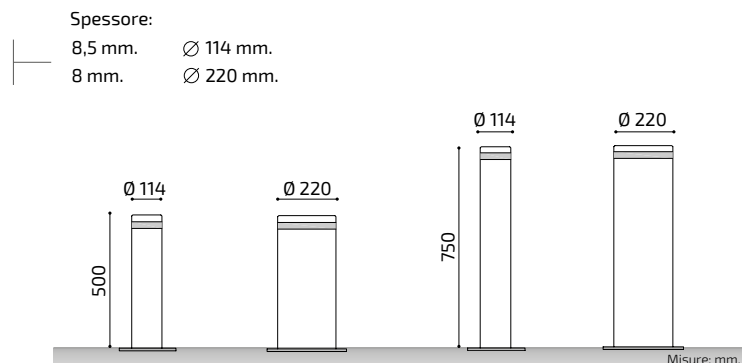

Installazione:



■ Su richiesta AISI 316.



### BRUSELAS (GAMMA ALTA)

FERRO ZINCATO



PEMBR220X500

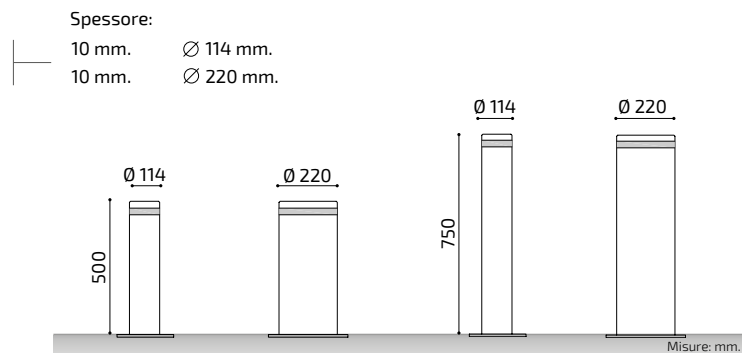

Installazione:



### CHELSEA (GAMMA ECONOMICA)

ACCIAIO INOSSIDABILE



PEMCH114X500

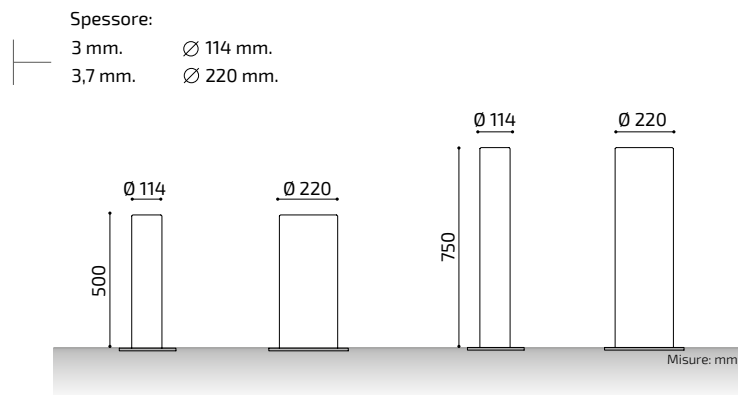

Installazione:



### LONDON (GAMMA ECONOMICA)

FERRO ZINCATO

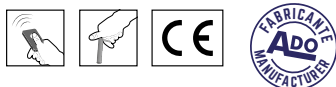

PEMLOS220X500

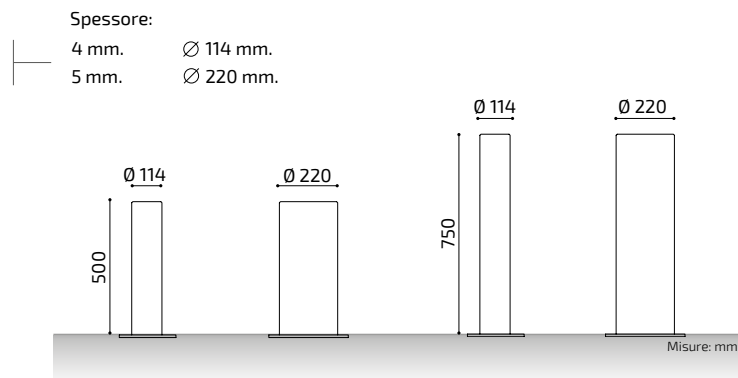

Installazione:



### BUENOS AIRES (GAMMA ALTA)

ACCIAIO INOSSIDABILE



PEMBU220X500

Spessore:  
8,5 mm. Ø 114 mm.  
8 mm. Ø 220 mm.

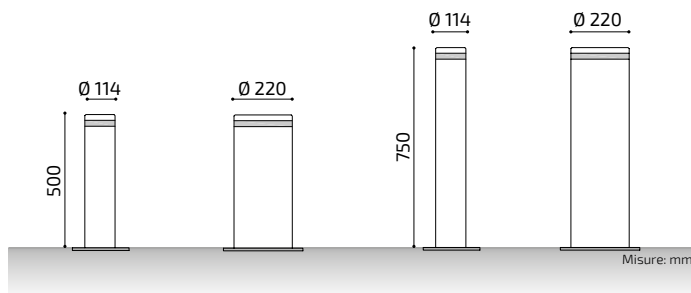

Installazione:



Chassis / Cassone a perdere.

■ Su richiesta AISI 316.

### ROSARIO (GAMMA ALTA)

FERRO ZINCATO



PEMRO220X500

Spessore:  
10 mm. Ø 114 mm.  
10 mm. Ø 220 mm.

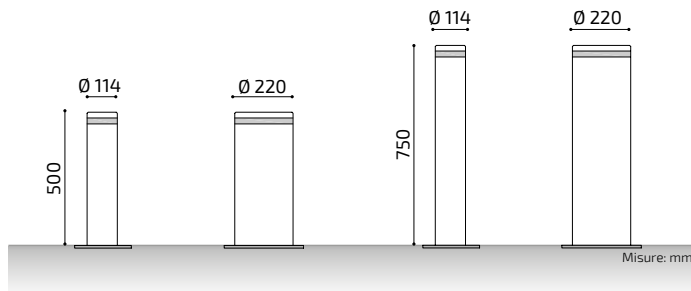

Installazione:



Chassis / Cassone a perdere.

### RIO (GAMMA MEDIA)

ACCIAIO INOSSIDABILE



PEMRI220X500

Spessore:

3 mm. Ø 114 mm.

3,7 mm. Ø 220 mm.

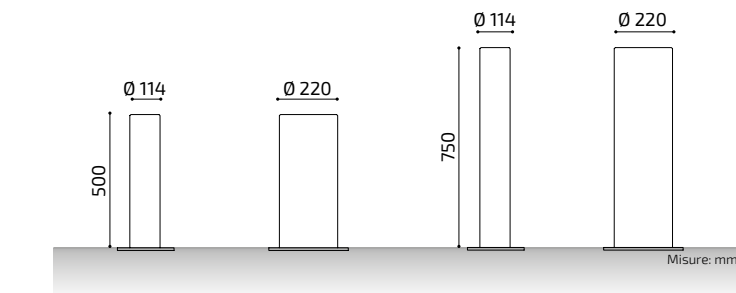

Installazione:



Chassis / Cassone a perdere.



Nastro catarifrangente facoltativo.

■ Su richiesta AISI 316.

### BRASILIA (GAMMA MEDIA)

FERRO ZINCATO



PEMBRA220X500

Spessore:

4 mm. Ø 114 mm.

5 mm. Ø 220 mm.

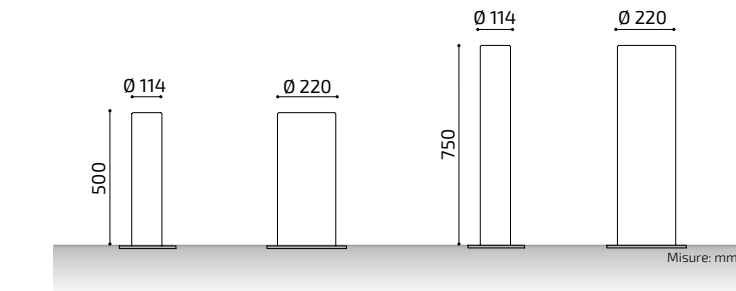

Installazione:



Chassis / Cassone a perdere.



Nastro catarifrangente facoltativo.



### ABU DABI (GAMMA ALTA)

ACCIAIO INOSSIDABILE

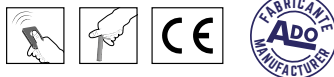

PEAB220X500

Spessore:  
8,5 mm. Ø 114 mm.  
8 mm. Ø 220 mm.

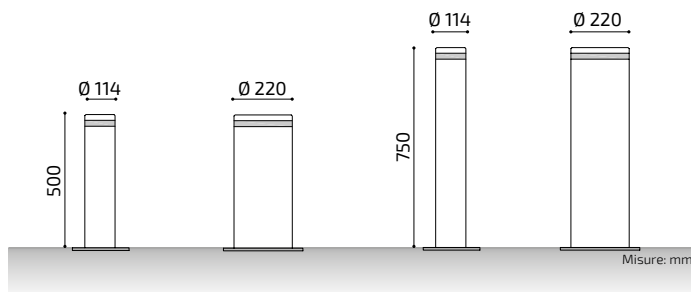

Installazione:



Chassis / Cassone a perdere

■ Su richiesta AISI 316.

### DUBAI (GAMMA ALTA)

FERRO ZINCATO

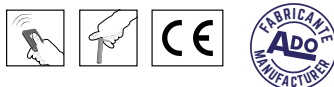

PEADU220X500

Spessore:  
10 mm. Ø 114 mm.  
10 mm. Ø 220 mm.

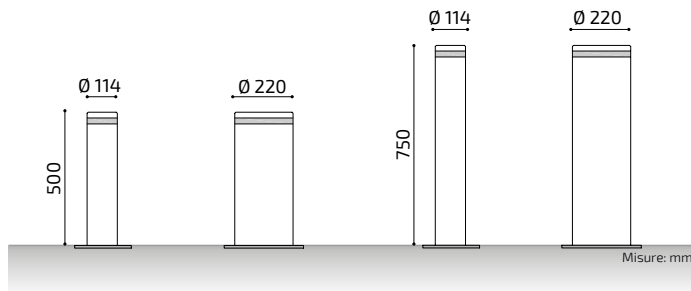

Installazione:



Chassis / Cassone a perdere

### TORONTO (GAMMA ECONOMICA)

ACCIAIO INOSSIDABILE

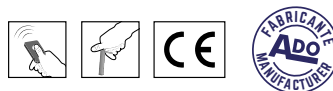

PEATO220X500

Spessore:  
 3 mm. Ø 114 mm.  
 3,7 mm. Ø 220 mm.

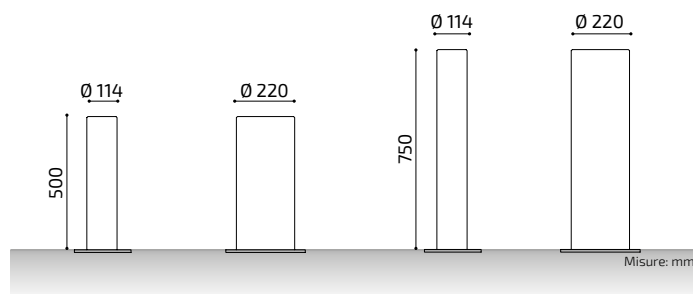

Installazione:



Chassis / Cassone a perdere



Nastro catarifrangente facoltativo.

■ Su richiesta AISI 316.

### MONTREAL (GAMMA ECONOMICA)

FERRO ZINCATO

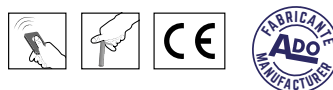

PEAMO220X500

Spessore:  
 4 mm. Ø 114 mm.  
 5 mm. Ø 220 mm.

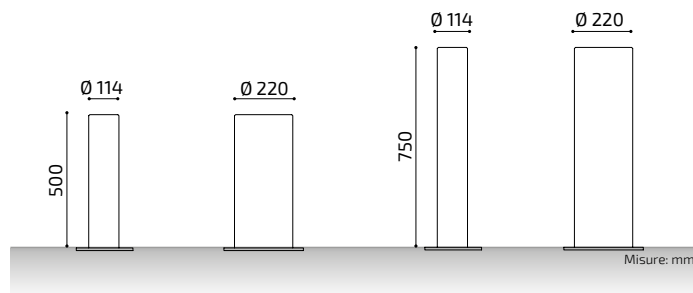

Installazione:



Chassis / Cassone a perdere



Nastro catarifrangente facoltativo.

### CANCUN (GAMMA MEDIA)

ACCIAIO INOSSIDABILE



PEMCA140X500

Spessore:  
 3 mm.    Ø 114 mm.  
 3,4 mm.    Ø 140 mm.  
 3,7 mm.    Ø 220 mm.

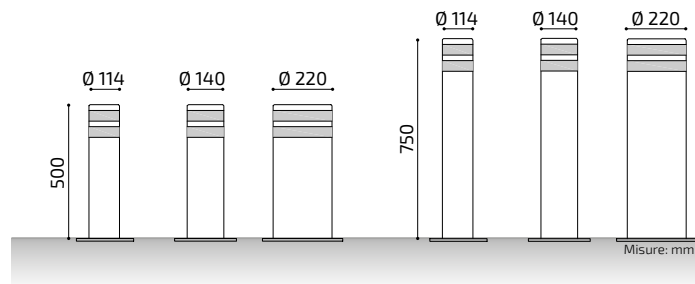

Installazione:



Chassis / Cassone a perdere.

■ Su richiesta AISI 316.

### TIJUANA (GAMMA MEDIA)

FERRO ZINCATO



PEMMO140X500

Spessore:  
 4 mm.    Ø 114 mm.  
 4 mm.    Ø 140 mm.  
 5 mm.    Ø 220 mm.

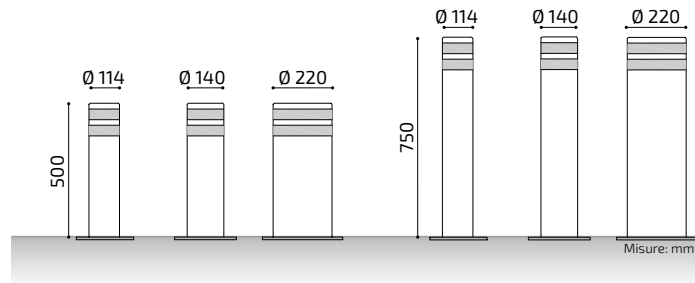

Installazione:



Chassis / Cassone a perdere.

### NEW YORK (GAMMA ALTA)

ACCIAIO INOSSIDABILE



PEANE273X750

Spessore:  
4,2 mm.    Ø 273 mm.

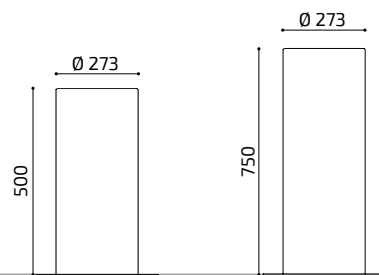

Misure: mm.

Installazione:



Chassis. +



Cassone a perdere.

■ Su richiesta AISI 316.



### WASHINGTON (GAMMA ALTA)

FERRO ZINCATO



PEAWA273X750

Spessore:  
6,3 mm.    Ø 273 mm.

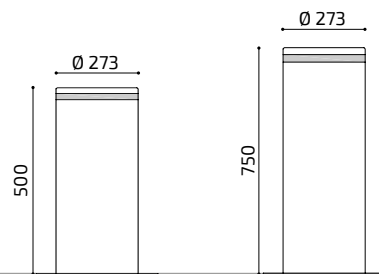

Misure: mm.

Installazione:



Chassis. +



Cassone a perdere.



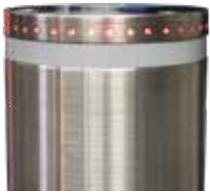

Corona luminosa CILPE.



Corona luminosa CILRA.



Corona luminosa CILMU.



Acciaio corten.



Fresatura extra.



Personalizzazione logo.



Dissuasore fisso coordinato.



Dissuasore pendenza.



Design speciali.



Cassone a perdere.



Copertura temporanea per cantiere.



Interruttori posizione.



Rilevamento apertura-copertura.



Rivelatore di massa metallica.



Kit di connessione.



Cartello traffico.



Semafori.



Climatizzazione.



Orologio programmabile dissuasore automatico.

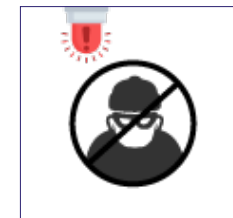

Allarme manomissione dissuasore.

## + | SISTEMI DI APERTURA



Telecomandi a distanza.



Chiave magnetica apertura.



Sistema TAG.



Serratura a scatto.



Pulsantiera.



Interfono GSM.



Sistema GSM.



Lettoce di targhe.



Codice a barre.

## + | SISTEMI DI APERTURA PER VEICOLI DI EMERGENZA

Rilevatore acustico (identifica il segnale di sirene omologate, ambulanze, polizia, vigili del fuoco, ecc.) e abbassa i dissuasori per consentire ai veicoli di emergenza di passare senza fermarsi.





Paletti di controllo in acciaio inossidabile con semaforo a led con possibilità di aggiungere accessori all'interno, come lettori di targhe, tastiere numeriche, lettori di carte, etc.

## URBAN

ACCIAIO INOSSIDABILE



PCACCES02



Protettore semaforo facoltativo

Altre misure su richiesta  
Su richiesta AISI 316.

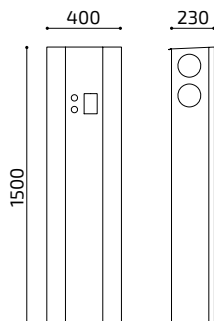

Misure: mm.

## METROPOLIS

ACCIAIO INOSSIDABILE



PCACCES04

Altre misure su richiesta  
Su richiesta AISI 316.

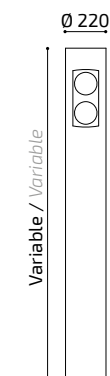

Misure: mm.



# + | ADATTAMENTO DISSUASORI ASCOMPARSA

Adattamento dei nostri dissuasori a scomparsa a cassone a perdere e/o chassis già installati da altri produttori. Consentendo la sostituzione del corpo del dissuasore e di altri componenti senza dover eseguire lavori di muratura.

Produzione di dissuasori e componenti secondo le esigenze del cliente, adattando elementi esistenti.







*EL CORTE INGLÉS*

**INSTALAZIONI  
DISSUASORI A SCOMPARSA**





FC BARCELONA





FC BARCELONA



MÉS QUE



AT. DE MADRID





BARCELONA





*SANTA COLOMA  
DE GRAMENET*





BARCELONA





Oficines  
CORNELLA  
i Serveis Tècnics







*CENTRO COMERCIAL  
LA MAQUINISTA*





CALELLA





BARCELONA





BARCELONA

TOUS





BARCELONA

**RABAT**  
BOUTIQUE

**RABAT**  
BOUTIQUE





GRAU  
BARCELONA



BARCELONA

PHILIPP PLEIN





BARCELONA





*LES FONTS*







BARCELONA





*SANT FELIU  
DE GUIXOLS*





*BADALONA*





MADRID

RABAT





*PRATS DE LLUÇANES*





MONTGAT





# HELLY HANSEN

BARCELONA

The store window display is a promotional advertisement for the Helly Hansen Ultratrail Collserola. It features a mannequin dressed in athletic gear, including a red and orange helmet, a grey jacket, a bright yellow-green shirt, and colorful trail shoes. The background of the window shows a white car parked on a street. To the left of the mannequin is a large vertical poster with the following text: 'HELLY HANSEN ULTRATRAIL COLLSEROLA', '22 NOV 2014', and 'www.ultratrailcollserola.com'. The poster also includes a map of the Collserola area and various logos of sponsors and partners. The window is framed by a red border, and the store's red roller shutter is visible to the right.



BARCELONA

Dior







*SANTA COLOMA  
DE GRAMENET*





BARCELONA





*SANTA COLOMA  
DE GRAMENET*





*ESPLUGUES*





CERDANYOLA





ULLASTRET





DOSRIUS



TORDERA





MADRID







TORREVIEJA





*BADALONA*

ADRI  
1000  
1000





*FABBRICA  
BADALONA*





*FABBRICA  
BADALONA*





# CONTATTO

## TECNICO COMMERCIALE

Ruben - ruben@adosa.es

+34 93 456 03 03 | +34 93 116 29 75

## ASSISTENZA TECNICA

Enric - enric@adosa.es

+34 93 456 03 03 | +34 93 116 29 75



## UFFICIO E FABBRICA

C/ Acer, 37 al 43. Polígono Industrial Les Guixeres.  
08915 Badalona.

+34 93 456 03 03

+34 93 116 29 75



## MAGAZZINO LOGISTICO

C/ Camí del Crist Polígono Industrial 2. Parcela 5.  
08340 Vilassar de Mar.

+34 93 395 79 17



## SHOWROOM E VENDITE

C/ Indústria, 173 baixos.  
08025 Barcelona.

+34 93 456 03 02